



SYNMEC INTERNATIONAL AGRICULTURAL MACHINERY 2019

**CLEAN THE WORLD'S GRAIN
PROCESS THE WORLD'S SEED**

Go green future
SYNMEC Grain Cleaning & Seed Processing Technology



www.synmec.com
SYNMEC INTERNATIONAL TRADING LTD.

Head Office:

Address: 15th Guangang Street, Shijiazhuang City,
Hebei Province, China 050011.

Tel: +86 311 67663887

Fax: +86 311 67663887

Mobile: +86 13273161281 (Tony)
+86 13273161282 (Joyce)
+86 13273161283 (Helen)
+86 13273161285 (Sam)

E-mail: inquiry@synmec.com
tony@synmec.com

Manufactory:

Address : Huaixi Industry Park, Hongqida Street,
Shijiazhuang City, Hebei Province, China 050000



© Copyright SYNMEC International 2019 森迈国际版权所有
Designed by Studio Reo



www.synmec.com

Healthy Grain, Pretty Beans, Strong Seed. **SYNMEC**

We serve for



CONTENT

Content	1-2
Company Introduction	3
Customer Visit	4
Exportation: Less Container Load and Full Container Load	5
Overseas On-site Assembly and Training	6
Introduction For Our Manufactory and International Certifications	7
Factory Introduction	8
720 ⁺ factory Virtual Tour	9
Manufacturing Processes	10
Seed Cleaner & Grader	11-14
Seed Cleaning & Processing Machine	15-16
Fine Seed Cleaner	17-18
Destoner	19-20
Gravity Separator (Air Blowing Type)	21-22
Gravity Separator (Air Suction Type)	23
Indented Cylinder	24
Seed Coating Machine / Seed Treater	25-26
Bagging Scale System	27-28
Elevator and Conveyor	29-30
Bean Polishing Machine and Belt Type Separator	31
Magnetic Separator	32
Drum Pre-cleaner	33
Laboratory Seed Equipment	34
Grading Machine, huller and Thresher	35-36
Seed Processing Line	37
Mobile Seed Processing Plant	38
Grain and Bean Cleaning Plant	39-40
Seed Processing Plant	41-42

COMPANY INTRODUCTION

Who we are

Business since 2002, based on Huaxi industry park, Shijiazhuang City, China. During over 20 years management, we become the worldwide successful manufacturer for grain cleaning & seed processing machinery, and the biggest one in China, has 11 hectare land with advanced processing equipment such as laser cutter, CNC lathe, etc. In year 2004, we start international trading, following 5 years we have rapid development on that, so at year 2010 we built our own international brand of grain cleaning & seed processing machinery, also founded an independent corporate entity "SYNMEC International trading Ltd.", that for provide better trading service for our oversea customer. Until now, we have sold our machines to more than 120 countries.

Our vision

The grain after harvest will contain many different impurities, such as dust, straw, stone, soil block, etc. The seed may moldy, damaged, illness and blighted, which may not germinate after sowing. The beans have mud on the surface which reduce its market price. We have the technologies and machine to build strong seed, healthy grain and pretty beans.

What we do

To build the machine for clean the post-harvest grain let them go to the market freely, advance cleaning remove the lose vigour seed, increase their germinate rate, polishing the bean make it shine increase its market price. We are the world top adviser for grain cleaning & seed processing solution. We have strong engineering group with well knowledge, all engineers are go aboard several times, know your grain, know your impurities, also with wider product range, so we can provide more solution for meet with your budget.



Since 2011, Our Australian client Engineer Mr Dean Frahn purchased one 5XZC-15 Seed Cleaner & Grader, following year he did huge research on that machine, at 2014 he worked closely with us for design a bulk grain cleaning machine for west world market, at 2014 winter the new developed model 5XZD-15AC Grain Cleaner has been produced which has humanization design, high mobility, large processing capacity and international high electrical standards.



Our Ethiopian agent, Mr Yigalem Tagel, purchased 24 sets Sesame & Pulses Cleaning Plant during 2011-2018



Our Nigerian agent Mr Bashir open a SYNMEC machinery office at No.15 Km Gunduzawa Hadejia Road,Kano State,Nigeria

CUSTOMER VISIT



One 2T/H Chia seed cleaning plant



Two 10T/H Wheat, Barley and peas cleaning plants



One 5T/H maize, paddy & soybean cleaning plant



One coffee bean hulling, cleaning & grading plant



Few grain cleaning machines



Two 5XZS-10DS Seed Cleaning & Processing machines



Many grain cleaning machines



Two 5XZS-10DS Seed Cleaning & Processing machines



One 10T/H sugar bean cleaning plant



Many grain cleaning machines



Many seed cleaner & graders



Many seed cleaning machines

Exportation: Less Container Load and Full Container Load



TQSF-80 Destoner

SXQX-5 Magnetic Separator

DXZC-3B Seed Cleaner & Grader

TQSF-60 Destoner

The machine has been well coated by white plastic film, fixed in the container by belt fasteners, strong iron wire and steel wedge, in that case the machine can be deliver well after ocean sailing, also save cost.



FCL SX-12 Fine Seed Cleaner and SXZ-10 Gravity Separator for America client in 2017

FCL SXQS-5 Destoner for Philippines client in 2017

FCL SXZD-15AC Seed Cleaner & Grader for Australia client in 2017

FCL SXZD-15AC Seed Cleaner & Grader For Australia Clients In 2017

The client is so serious and responsible. He make machine loading layout for the container, even load by himself. Photos show clients monitoring loading by himself. We learned many for him



Oversea On-Site Assembly and Training



2017



2017



2017



2017



2016



2015



2014



2015

SYNMEC & RUIXUE

Introduction for our manufactory 'RUIXUE Grain Selecting Machinery' and International certificates



We are an international trading company also a professional manufacturer for grain cleaning and seed processing machinery. Our manufactory's name is Hebei Ruixue Grain Selecting Machinery CO., Ltd, SYNMEC as an international brand of 'RUIXUE grain selecting machinery', also it is an independent corporate entity 'SYNMEC International trading Ltd.', so we can provide professional machinery making and professional international trading service.

History

- 1997 Business started and factory was established.
- 2002 Ruixue Grain Selecting Machinery Co., Ltd. start to manufacture seed cleaning and processing machinery.
- 2004 Start international trading
- 2009 Rapid growth period for overseas market.
- 2010 We founded SYNMEC International Trading Ltd. for provide better international trading serve
- 2013 SYNMEC service 76 countries, help they obtain strong seed, healthy grain and pretty beans, in the same we upgrade to level B international trading company in China.
- 2014 New factory opened, one group can to running business in here.
- 2015 Exported to over 100 countries and upgrade to Level A.
- 2016 Old factory closed, all staffs happy to work in the new factory.
- 2017 Exported our machines to more than 110 countries.
- 2018 Exported machines to more than 120 countries.



FACTORY INTRODUCTION

Our factory has 11 hectares and it is located in Huaxi Industrial Park, Shijiazhuang city. New office building is 4000 square meters. There are four workshops in the landscape, now three of them are ready.



720° FACTORY VIRTUAL TOUR



Scan the QR code to start 720° factory virtual tour. Or use following link:
<https://world-port.made-in-china.com/viewVR?deSpaceId=76034>

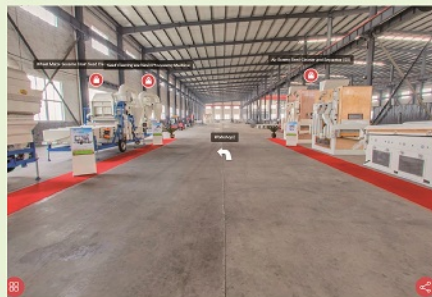

Click the inside machine which in workshop 1, then will display the machine information and video.

MANUFACTURING PROCESSES

We have the best processing equipment in Chinese agricultural machinery factories. There are two American brand laser cutters, one brand new Germany brand laser cutter, six CNC steel bending and cutting machines and American brand plasma cutter service us. We also have the automatic shot blasting machine and electrostatic powder injection plant in our workshop.



5XZC Seed Cleaner & Grader

Seed cleaner & grader becomes basic and most favorite cleaning machine in seed and grain industry of global market, with high efficiency, excellent performance, and wide application. It's suitable for processing all kind of seeds, cereals, grains species and crops, such as wheat, paddy, rice, barely, maize, millet, cumin, sunflower seed, soybean, coffee bean, cocoa bean, oilseeds, etc.

The 5XZC-7.5DS has double air cleaning system, which will lead to better air cleaning results.

The Cyclone dust separator with air locker are used for collecting the light impurity and dust which sucked by air blower, the cyclone dust separator is highly technical equipment which can collect most of dust and light impurity.

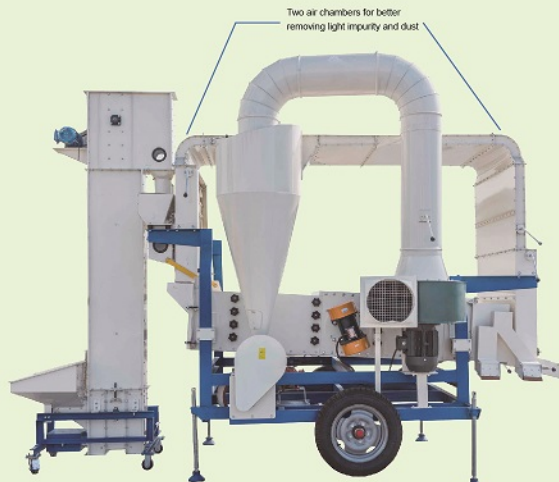

5XZC-7.5DS Seed Cleaner & Grader (double air cleaning system)

Seed cleaner & grader is used for cleaning and grading seeds, grains, cereals, and other granule products. It can be equipped to suit a variety of special jobs and purposes.

Dust and light impurity are removed by aspirator fan. Material falls on sieve layers and was separated by sieves according to width and thickness difference. All the oversize and undersize impurities were discharged from outlets.

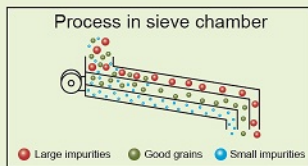

The 5XZD-15AC Grain Cleaner & Grader is designed by Australian engineer (Mr. Dean Frahn), dedicated in bulk grain cleaning for west world market. It has high mobility, large processing capacity, international high electric standards and machine manufacture, unique design features. It's the best grain cleaning equipment for Australia, USA, Canada, Brazil and other bulk grain processing market.



5XZD-15AC Grain Cleaner & Grader

Features:



High quality famous brand electric apparatus professional wiring mode meet Australian standard and strict wiring specification.



New model grain cleaner creatively adopt deck compounded design. Two isolated 3 layers sieving trunks doubled machine capacity, meet bulk grain cleaning requirement.

Other Models of 5XZC Seed Cleaner & Grader

Seed cleaner & grader becomes basic and most favorite cleaning machine in seed and grain industry of global market, with high efficiency, excellent performance, and wide application. It's suitable for processing all kind of seeds, cereals, grains species and crops, such as wheat, paddy, rice, barely, maize, millet, cumin, sunflower seed, soybean, coffee bean, cocoa bean, oilseeds, etc.



5XZC-3B



5XZC-3C Installed Wheat Huller



5XZC-3DS Double Air Cleaning System



5XZC-5A Installed Maize Thresher



5XZC-5DH Installed Cyclone



5XZC-5CDH Installed Wheat Huller And Cyclone



5XZF-7.5F With Destoner Plate



5XZC-15 Installed Cyclone



5XZC-15A Installed Maize Thresher



5XZC-25 Double Air Cleaning System

Model	Capacity(ton/hour)	Power(kw)	Weight(kg)	Dimension (mm)	Remarks
5XZC-3A	3	8.5	1300	3750x1950x2750	Installed Maize Thresher
5XZC-3B	3	4.25	1200	3750x1650x2750	Grain Cleaning And Grading
5XZC-3C	3	7.25	1300	3750x1650x2750	Installed Wheat Huller
5XZC-3DH	3	5	1300	3970x1800x2750	Installed Cyclone Dust Separator
5XZC-3DS	3	7.5	1400	4470x1800x2850	Double Air Cleaning System
5XZC-5A	5	12.74	1600	4650x2120x3100	Installed Maize Thresher
5XZC-5B	5	6.99	1500	4650x1900x3100	Grain Cleaning And Grading
5XZC-5C	5	10.99	1600	4650x1900x3100	Installed Wheat Huller
5XZC-5DH	5	7.74	1600	4970x1900x3100	Installed Cyclone Dust Separator
5XZC-5CDH	5	11.74	1700	4850x2050x3550	Installed Wheat Huller And Cyclone
5XZC-7.5C	7.5	15.6	2000	5600x2000x3200	Installed Wheat Huller
5XZC-7.5D	7.5	10.1	1700	5600x2000x3200	Installed Cyclone Dust Separator
5XZC-7.5DS	7.5	9.9	1770	3920x2430x3440	Double Air Cleaning System
5XZC-15	10	10.5	1800	5600x2100x3200	Installed Cyclone Dust Separator
5XZC-25	20	19.45	2900	5820x2650x3600	Double Cyclone Dust Separator
5XZD-15AC	20	10.45	3000	5140x2340x3820	Double Sieving Trunks
5XZF-7.5F	7.5	10.1	1800	5150x2160x3400	With Destoner Plate

5XZS Seed Cleaning & Processing Machine

The 5XZS-10DS Seed Cleaning & Processing Machine's function: wheat hulling (optional), air cleaning, vibration sieve pre-cleaning, gravity separating and vibration sieve fine cleaning.



Wheat are fed into wheat huller (optional) to shell, then lifted up by bucket elevator, enter to small vibratory sieving trunk for quick removing small, large impurity, and light impurity, then wheat enter to gravity table for removing the bad seed (partially eaten, immature, insect damaged, sick seed, etc.). Finally wheat enters to the vibratory sieving trunk for removing large & small impurity again, also grading seed to different size ranks. Wheat from outlets becomes seed which can be sowed in ground directly.

5XZS-20DS Seed Cleaning & Processing Machine's function: Double air cleaning, vibration sieve pre-cleaning and gravity separating

5XZS-20DS Seed Cleaning & Processing Machine: The grain seeds are lifted up by the bucket elevator and enter to vibratory sieving trunk for quickly removing small and large impurity, at same time, the double air cleaning system remove the light impurity. Then the air cleaned seed enter to the gravity table for remove the bad seed (partially eaten, immature, insect damaged, sick seed, etc.). The grain after processed by that machine become seeds which can be sowed directly.

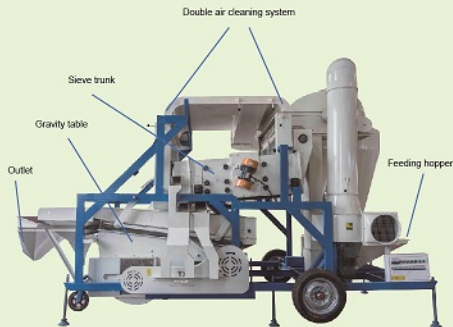

Model	Capacity (ton/hour)	Power (KW)	Weight (kg)	Dimension Length*Width*Height (mm)	Remark
5XZS-10CDS	10	23.25	3200	6500*2200*3600	With wheat huller
5XZS-10DS	10	15.75	2900	6500*2200*3600	
5XZS-20DS	20	21.49	2600	4730*2500*3830	

5XZS-10DGT Seed Cleaning & Processing Machine

Function: wheat hulling (optional), air cleaning, pre-cleaning by two layers sieving trunk, two time gravity separating and four sieve layers fine sieve cleaning.

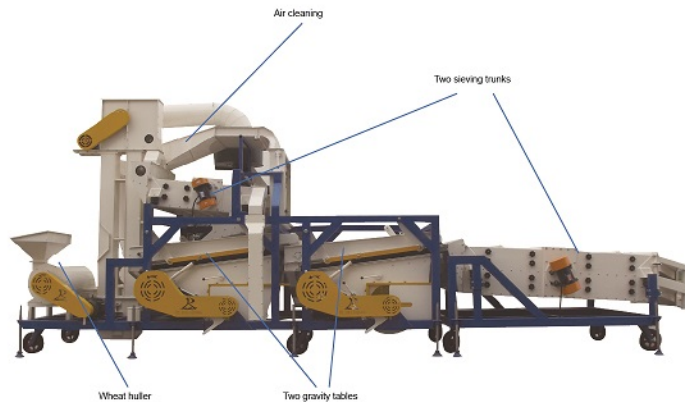

Wheat are fed into wheat huller to hulling, then lifted up by bucket elevator, enter to pre-cleaning vibratory sieving trunk for quick removing small, large impurity, and light impurity, then wheat enter to two gravity tables for removing the bad seed (partially eaten, immature, insect damaged, sick seed, etc.). Finally wheat enters to the second vibratory sieving trunk for removing oversized & under size impurity again, also grading seed to different sizes. Wheat from outs becomes seed which can be sowed in ground directly.



Model	Capacity (ton/hour)	Power (KW)	Weight (kg)	Dimension Length*Width*Height (mm)	Remark
5XZS-10DGT	10	30.75	4200	8600*2300*3600	With wheat huller

5X Fine Seed Cleaner

5X Series Fine Seed Cleaner adopting the international advanced technology, developed by powerful research is a world-class localization air screen type cleaning equipment. It can be widely used for processing wheat, rice, corn, barley, peas and many other seed. It can also be used for all kinds of grain selection process.

The 5X Series Fine Seed Cleaner is a universal machine well suited for pre- and fine cleaning many different species of grain and seeds. The standard design of the machine is provided with both pre- and after suction units. Quick screen changing from pre-cleaning into fine cleaning by the operator serves to optimize the cleaning tasks.

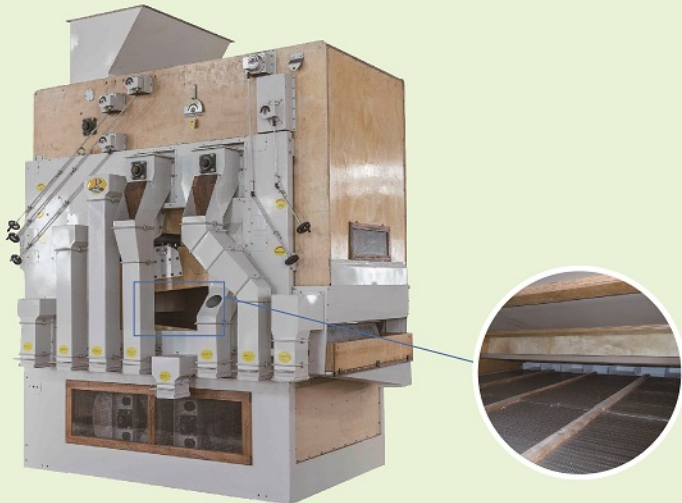

5X-5 Fine seed cleaner

The inside sieve



Two air blowers in the bottom

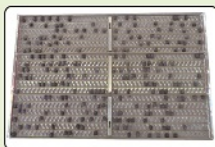

New design rubber ball holding tray



Easy to change the sieve

Air cleaning and sieve separating for 5X series Fine Seed Cleaner

The sieve separating effect of the 7m² (for 5X-5) and 15m² (for 5X-12) total screen area is increased by SYNMEC's highly effective pre and after suction system, extracting light impurities and dust from the material both at the machine inlet and outlet. The exhausted waste, dust and lightweight trash is deposited in two separate expansion chambers and conveyed to the machine outlets by two discharge augers which are equipped with a multi-flap air system to prevent ingress of air. The expansion chambers are designed for connection to a separate exhaust air blower.

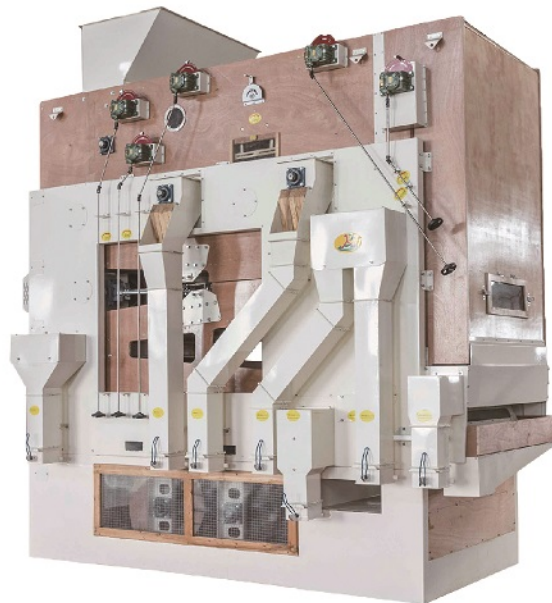

5X-12 Fine seed cleaner

Model	Capacity (metric tons per hour)	Power (KW)	Weight (kg)	Dimension Length* Width*Height (mm)	Sieve layers	Total screen area (m ²)
5X-5	5	6.7	2400	2950*1750*3600	4 Layers, 7 Sieves	7
5X-12	12	6.7	3600	3720*1750*4080	5 Layers, 15 Sieves	15

5XQS Destoner

The destoner is widely used for grain cleaning and food processing. It can remove sand, stones, pebble and other impurities from rice, wheat, corn, sesame etc. Compact structure, good sealing, low noise, low energy consumption, stable operation, good cleaning effect and high production efficiency.



5XQS-10 Destoner

5XQS series destoner is air blowing type, air blower placed at the bottom of destoner. It is used to remove heavy foreign impurity like stone, metallic, and glass pieces etc on the principle of weight difference. With the combination of fluidization and deck oscillation, heavy particles migrate to upper levels of the deck discharge from cullets and the light particles move to the lower level of the deck.

Model	Capacity (ton/hour)	Power (KW)	Weight (kg)	Dimension Length* Width*Height (mm)	Air blower	Remarks
5XQS-3	3	5.5	600	2200*1200*1600	2	Air blowing type
5XQS-5	5	7	700	2500*1560*1600	3	Air blowing type
5XQS-10	10	9.7	900	2500*2300*1600	4	Air blowing type

TQSF Destoner

TQSF Series Destoner works for continuous separation of stone from a stream of grain. This machine has a work surface with two sieves: the first divides the flow of grain into light and heavy parts, the second separates the foreign bodies with specific weights higher than that of grain, such as stone and bit of glass and metal.

It is a high efficient and multi-functional grain cleaning equipment.



TQSF-80 Destoner

Model	Capacity (ton/hour)	Power (KW)	Weight (kg)	Dimension Length* Width*Height (mm)	Remarks
TQSF-60	5	3.5	320	1350x860x1800	Air suction type
TQSF-80	7.5	3.5	400	1350x1050x1800	Air suction type
TQSF-100	10	6	500	1450x1216x1800	Air suction type
TQSF-125	12.5	6	580	1460x1500x1940	Air suction type

QXS Destoner

The QXS-85 combined effect of the vibrating movement and the air passing through the deck causes an arranging in layer of the material flowing in (fluidisation). The heavy admixtures are moved to the highest point of the table deck surface (stone outlet) by the contact with the rough deck covering. The main product (clean product) floats towards the top and flows, against the conveying direction of the table, to the lowest point of the deck surface, finally released from the outlet.



QXS-85 Destoner

Model	Capacity (ton/hour)	Power (KW)	Weight (kg)	Dimension Length* Width*Height (mm)	Remarks
QXS-85	5	3.55	400	1300x1500x3200	Air suction type

5XZ Gravity Separator (Air Blowing Type)

Gravity separator is suitable for efficient cleaning all of cereals, grains, pulses, beans and seeds of all crops such as coffee bean, wheat, paddy, barley, maize, millets, sunflower seed, soybean, oil seeds, rice etc.

5XZ Series gravity separator is used to separate material which in same size but different in specific weight. It can efficiently remove partially eaten, immature, insect damaged, sick seeds from good seeds. To achieve high grading quality of seed, gravity separator become the basic machinery for seed company.



5XZ-6 Gravity Separator with Slope Elevator



5XZ-3 Gravity Separator



Mobile Type 5XZ-6 Gravity Separator

5XZ-3/6/10 Gravity Separator (Air Blowing type) works on a fluidized bed principle. Material is fed on oscillating sieve deck. By the pressure of air & deck oscillation, material is fluidized and stratified. Heavy fraction sink into the deck while light fraction suspend in fluidized state. Deck oscillates causing heavy and light fraction travel in separate paths and collected separately.



5XZ-10 Gravity Separator



Vibrating passway for collecting the good seed



Top quality stainless steel sieve bed with wooden boundary



Six individual Mute Air Blowers (low noise, the front three are 1.8kw each, while the back three are 1.5kw each)

Model	Capacity (ton/hour)	Power (KW)	Weight (kg)	Dimension Length*Width*Height (mm)	Remarks
5XZ-3	3	7.45	1300	2600*1500*1750	3 mute air blower
5XZ-6	5	8.95	2000	3440*1630*1900	4 mute air blower
5XZ-10	10	15	2500	4300*1960*2500	6 mute air blower

5XZ Gravity Separator (Air suction type)

5XZ-5B has double vibratory motors which is our patent design. As two vibratory motors can generate a vibratory balance so don't need rubber absorber. This new design offer better separating performance, high capacity, also save maintenance cost. Patent No.: 201120165288.X.



5XZ-5B Gravity Separator



5XZ-3B Gravity Separator



5XZ-5A Gravity Separator



5XZ-10B Gravity Separator

5XZ-A/B series Gravity Separator is used to separate the bad seed which is same size but different in specific weight with good seed. It is movable machine mounted with feeding elevator. Air Lifting system adopt excellent air distribution system which ensure seed fluidized efficiently. Meanwhile no need extra dust hood. It is widely used in grain seed industry. Bring best performance for wheat, maize, barley etc.

Model	Capacity (ton/hour)	Power (KW)	Weight (kg)	Dimension Length*Width*Height (mm)	Sieve Size Length*Width (mm)	Remarks
5XZ-3A	3	5	1200	4000×1800×2750	2000×325	Air Suction Type with Cyclone Dust Separator
5XZ-3B	3	4.25	1100	4000×1800×2900	2000×325	Air Suction Type
5XZ-5A	5	9.62	1600	4000×1900×3100	2000×475	Air Suction Type with Cyclone Dust Separator
5XZ-5B	5	9	1550	4000×2050×3100	2000×625	Air Suction Type
5XZ-10B	10	17.3	2150	3800×2100×2600	2000×1250	Air Suction Type

5XWY & 5XWM Indented Cylinder

The indented cylinder is a secondary cleaning equipment for separation and classification of grains.

It grades the grain & seeds according to length. It can separate the longer or shorter impurities from granular material. Indented cylinders are used for length grading of all granular materials such as wheat, oat, maize, rice, fine seeds, lentils, sticks from sunflower or sugar beet, plastic particles etc., as well as for the extraction of unwanted short or long admixtures.

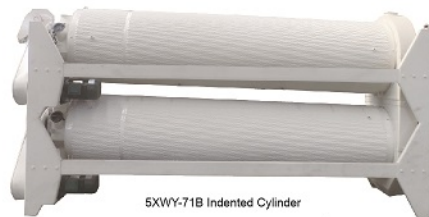

5XWY-71B Indented Cylinder



5XWM-71X56D Indented Cylinder

Model	Capacity (ton/hour)	Power (KW)	Weight (kg)	Dimension Length*Width*Height (mm)
5XWY-71A	2	1.1	610	3300×1100×1100
5XWY-71B	5	2.2	1200	3300×1100×2000
5XWY-71C	6	3.3	1800	3500×1100×3100
5XWM-71X41S	15	5.5	2300	3750×1100×2700
5XWM-71X56D	9	5.9	2500	3800×1100×2700

5BY Seed Coating Machine(Seed Treater)

The 5BY series seed coating machine is a decent choice for seed coating jobs. It applies for various crops, such as seed of wheat, barley, maize, sorghum, soybeans, cotton, vegetables, fruits etc.

5BY-5B & 10B Working Principle:

Seeds can be continuously fed into mixing cylinder through feeding bucket elevator, at the same time quantitative medicine liquid will be supplied by dosing pump, and then atomized by the high speed centrifugal rotary disk, following adhere to the surface of seeds, at the end completely mixed by the auger in the cylinder. High speed centrifugal rotary disk (for atomizing the liquid medicine) and large stainless steel cylinder (for mixing by auger rolling), can have a good coating effect.



5BY-5B Seed Coating Machine



5BY-10B Seed Coating Machine



Using high quality dosing pump, which can provide precise coating medicine supply.



Coating medicine heating tank is available, which used for cold temperature area.

Model	Capacity (ton/hour)	Power (KW)	Weight (kg)	Dimension		Coating Medicine Inject Method
				Length* Width*Height (mm)		
5BY-5A	5	4.5	800	2200*900*2500		Spoon
5BY-5B	5	2.3	700	2150*800*2600		Dosing Pump
5BY-10B	10	4.51	1100	2230*1040*3080		Dosing Pump

5BY-5A Working Principle:

Seeds will be quantitatively fed into the rotary cylinder through feeding bucket elevator, at the same time quantitative medicine liquid will be atomized by air compressor and sprayed to the surface of seeds, and then will well mixed in the rolling cylinder. The seeds will be coated with liquid chemical before sowing, for against the different pest and diseases, lead to better germination.



5BY-5A Seed Coating Machine

Seed coating result



5XHG-5 Drying Machine

5XHG-5 Drying Machine

It is mainly used for seed drying after seed coating, it has a simple heated device. There are nine heating wires in the front and one air blower in back. The hot air will be sucked into the cylinder by air blower. It is a continuous type.

Model	Capacity (ton/hour)	Power (KW)	Weight (kg)	Dimension	
				Length* Width*Height (mm)	
5XHG-5	5	13.5	900	4260*900*2310	

DCS Bagging Scale System

DCS-B/S Series Bagging Scale System is suitable for packing open-mouth bags made from paper, plastic, jute paper, or cotton with a filling weight ranging from 5 - 25 kg or 10 - 50kg depend on customer request and weighting sensor. Its capacity ranges from 4 to 6 bags per minute. This bag packing machine can be applied both for free flowing and non-free flowing granule materials, such as the seeds, grain, feedstuff, chemical raw material and chemical fertilizer etc.

ADVANTAGES:

- High calculating precision, rapid packaging speed, stable function, easy operation.
- Adopt advanced techniques on control instrument, sensor, and pneumatic components.
- Advanced functions: automatic correction, error alarm, automatic error detection.

DCS-B Bagging Scale System

The DCS-B/S bagging scale system is ideal for packing the granule material, such as the seed and agricultural product etc.



DCS-50B Bagging Scale System

DCS-S Bagging Scale System

It has double weighing system, so its bagging speed is faster than DCS-B Series.

Filling weight 1-10kg, 5-25kg, 10-50kg.

Its capacity ranges between 7 and 14 bags per minute.

One DCS bagging scale system includes:

- One Bagging Scale
- One DTY Bucket Elevator
- One Air Compressor
- One Belt Conveyor
- One Bag-sewing machine (or bag heat-sealing machine)



DCS-25S Bagging Scale System

Model	Weighting Range (kg)	Accuracy	Throughput (bags/hour)	Working Environment	Air Compressor Power
DCS-10B	1-10	0.5%F.S.	> 360	-10°C~+40 Relative Humidity ≤90%	1.5KW 0.17MPA
DCS-25B	5-25	0.5%F.S.	> 360		
DCS-50B	10-50	0.5%F.S.	> 240		
DCS-10S	1-10	0.5%F.S.	> 700		
DCS-25S	5-25	0.5%F.S.	> 600		
DCS-50S	10-50	0.5%F.S.	> 400		

ADCS-1S Full Automatic Packing Machine (for small bag which below 1KG)

ADCS-1S is suitable to pack small granular products, such as peanuts, pinenut, tea, seeds, beans etc. It automatically packs these products into plastic pouch, PE/laminated film and so on. We use the newest control method and device of imported clutch to control bag. Good sealing performance, widely used in food factory, grocery, seed company, farm and other place.



You can adjust the weight volume by adjusting the height of measuring cup.



ADCS-1F Full Automatic Packing Machine (for small bag which below 1KG)



Adjust the feeding screw (set its number of turns) to control feeding volume, lead to obtain different packing weight. You can also change different diameter feeding screw, lead to obtain other weighing range. The screwing feeder is easy to install and change.

ADCS-1F is used for automatic packing food, medicine, chemical and other powder materials, such as spice powder, flour, milk powder etc. The machine adopts the stepping motor to control the bag length, computer control mode. The main features: Intelligent photoelectric tracking, adjusting easily and tracking accurately.

We can also provide some other equipment for complete packing system such as bucket elevator or stainless steel auger, date printer, etc.

Model	ADCS-1S
Metering Range (KG)	0.1-1
Bag Size (mm)	L80-300 W80-210
Power (KW)	1.8
Bagging Speed	15-40 bags per minute
Accuracy	±0.05%
Weight (KG)	350

Model	ADCS-1F
Metering Range (KG)	0.1-1
Bag Size (mm)	L: 70-300 W: 80-200
Power (KW)	1.8
Bagging Speed	20-40 bags per minute
Accuracy	±0.05%
Weight (KG)	400

DTY Bucket Elevator

The Bucket Elevator is mainly designed for continuous vertical lifting operation of powdery, granular and small lump stocks. It is extensively applied to lift bulk stocks for feeding stuff plants, flour mill, starch factory and grain depot of different scale.

Features:

- Rugged design
- Durable operation
- Reliable operation
- Long service life



DTY Bucket Elevator



DTY-E Bucket Elevator
(low damage rate)

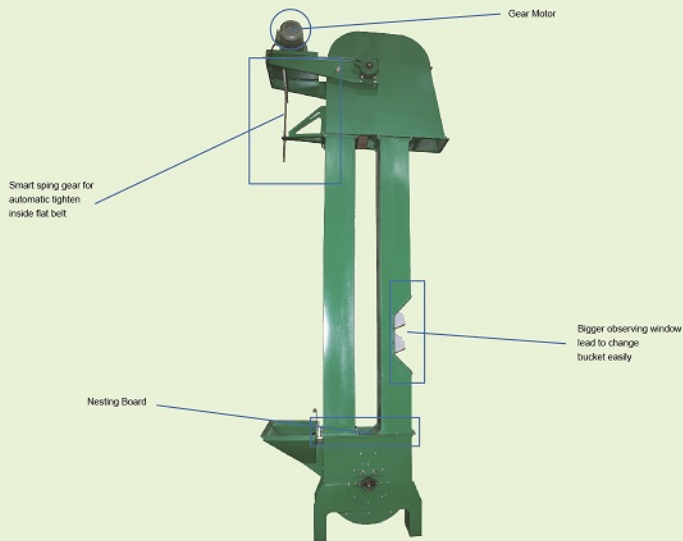

Smart spring gear for automatic tighten inside flat belt

Gear Motor

Bigger observing window lead to change bucket easily

Nesting Board

DTY-S Bucket Elevator (very low damage rate)

Z type Bucket Elevator

Features:

- Zero damage for materials
- Hopper is made of food-grade polypropylene (PP)
- With artistic looking
- Resistance of heat and cold

Z type Bucket Elevator can be used for continuous weighing machine, or in packaging production line for equipment connecting.



Belt Conveyor



This belt conveyor is used for horizontal or inclined conveying the materials, such as wheat, corn and other most kinds of seeds and bulk materials and granules to the seed processing lines or granary, storage bins.

Slope Elevator

The slope elevator is used to transport the seed or other materials to a certain height with zero damage, when processing seeds or other dry materials.

It is very suited for a broad range of free flowing products in the grain, food, agriculture, pharmaceutical, cosmetic, chemical industry, such as beans, peanuts, raisin, dry vegetables and fruits, confectionary, chemicals and other granules.

The Slope Elevator belt is rather soft which results in extremely eliminating the damage. Also the sidewall and baffle on the slope elevator can prevent falling and sliding the lifting materials.

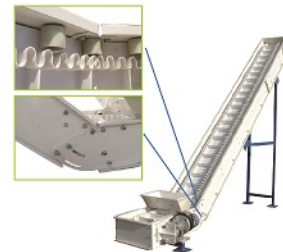

Full 304 stainless steel auger is available

Auger-Type Elevator

The Auger-type elevator can lift the grain and discharge it in to processing machine or packaging machinery as required.

The length and diameter of the elevator can be customized by client's request. It was widely used for many areas.

5PJ Bean Polishing Machine

The 5PJ series bean polishing machine is able to provide polishing process and remove the dust and surface soil of various beans, thus produce shiny, pearly, smooth and dust free beans, lead to increase commercial sale price. Base on safe, easy to use, high efficiency and simple structure, this machine is used and accepted by farmers around the world.



5PJ-5 Bean Polishing Machine

Model	Capacity (ton/hour)	Power (KW)	Weight (kg)	Dimension Length*Width*Height (mm)
5PJ-3	3	3.75	250	2000*600*1300
5PJ-5	5	6.25	450	3140*700*1830

5XDC Belt Type Separator

5XDC series belt type separator is specially used for round beans. It has multi-layers, and used to remove half beans, damaged beans and other irregular particles from round beans, like soybean, mung bean, red bean, etc. This machine has been used widely in bean cleaning sector.



5XDC-4 Belt Type Separator

Model	Capacity (ton/hour)	Power (KW)	Weight (kg)	Dimension Length*Width*Height (mm)
5XDC-3	3	2.2	1200	3700*2000*2900
5XDC-4	4	3	1600	4100*2000*2900
5XDC-5	5	4	1800	4500*2000*3300

Magnetic Separator



5XCX-5 Magnetic Separator

5XCX-5 Magnetic Separator is used to separate metals or clods from grains or seeds. Grain mixed with metals or clods go through a closed strong magnetic field with appropriate speed. Due to the different attraction strength of the magnetic field, metal, soil and clods are separated from grain.

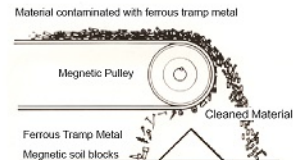

Dimension (L*W*H)	Capacity (ton/hour)	Width for magnetic surface	Clod election	Power (KW)
1800*1800*2000	5	1300mm	99%	1.1

Other type Magnetic Separator



TCXD Magnetic Separator

TCXD series Single Roller Magnetic Separator can remove metals and other magnetic impurities from grain. It can automatically release the impurity.



TCXT Magnetic Separator

TCXT Magnetic Separator can separate metals from material when materials fall down and go through the drum. This Magnetic separator can be installed at the outlet of our cleaning machine.

5XZP-S Drum Type Pre-Cleaner

5XZP-S series Drum Type Pre-Cleaner compose of machine frame, inclined drum, gear, support components. it is mainly used to remove the large impurities. When the materials fall into the rotating drum, the materials that smaller than the sieve mesh will fall into the outer cylinder, and large impurities will rotate with drum and gradually expel from the outlet.



5XZP-100/125S Drum Type Pre-Cleaner

Model	5XZP-85*100S	5XZP-125*150S	5XZP-125*250S	5XZP-125*320S	5XZP-160*425S
Capacity(T/H)	20	50	80	100	200
Power(KW)	1.5	2.2	2.2	3	4
Weight(KG)	400	550	600	700	1000

5XZP-D Drum Type Pre-Cleaner

5XZP-D series Drum Type Pre-Cleaner has double drum screen, it can effectively separate the light impurities, big impurities and small impurities from the grains. With the inclination angle screen drum and the independent support plus the aspiration device, the pre-cleaner is featured with steady operation and good cleaning effect. We can provide pre-cleaner for different grains with different screen size at different capacity.

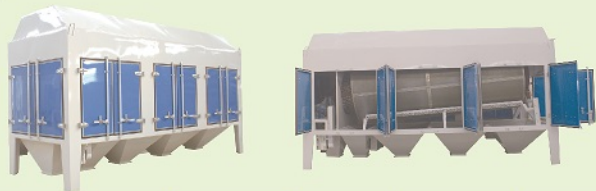

Model	5XZP-85*190D	5XZP-100*220D	5XZP-100*320D	5XZP-100*420D	5XZP-125*420D
Capacity(T/H)	60	80	110	140	170
Power(KW)	2.2	2.2	3	4	4
Weight(KG)	500	600	700	850	900

Laboratory Seed Processing Equipment

5XZC-L Seed Cleaner & Grader

The 5XZC-L seed cleaner & grader is a lab used seed cleaner for small capacity seed cleaning and grading. It suitable for cleaning the small grain, grass seed, flower seed, vegetable seed, herb seed etc.



5XZL-L Gravity Separator

The 5XZL-L gravity separator is used for separating seeds by specific gravity difference. It removes the granules that with heavy specific gravity (like gravel, soil particles), and remove granules that with light specific gravity (like moldy seeds, pest eaten seeds).



5XQS-L Destoner

The 5XQS-L Destoner is used to separate stones, sand, soil particles from seeds by different specific gravity. It often used for small seeds, such as vegetable seed, forage seed, flower seed etc.



5XFX-L Seed Air Cleaner

5XFX-L Seed Air Cleaner is working according to gravity weight and wind speed difference to separate small volume seeds. By air separation, it can grade into heavier seed, light impurities and dust. That will be easier for size separation of heavier seed by subsequent machines.



Model	Capacity (kg/h)	Air blower power (KW)	Vibration Power (KW)	Dimension(mm)
5XZC-L	100	0.55	0.37	1500*1170*2220
5XZL	50	0.37	0.13	1000*700*1440
5XQS-L	50	0.37	0.13	1000*700*1440
5XFX-L	50	0.37		1000*750*1680

Seed Grading Machine

The 5XFJ series grain & seed grading machine include a bucket elevator, and it is driven by two vibratory motors that lead to long life cycle and no maintenance cost. It can grade all types grain & seed, just by changing the inside sieve meshes which is very easy.



The 5XFT series grain & seed grading machine drive by eccentric shaft which provides higher amplitude. It can grade all types grain & seed just by changing the inside sieve. There are four models which are different on the length of sieving trunk, The longer trunk lead to better grading result.

5XQS-1 Destoner

It can remove sand, stones, pebble and other heavy impurities from rice and other grain, the working principle is based on grain and stones are different in specific gravity weight.



Thresher



QRT-300 Paddy & Wheat Thresher



KT-100 Paddy & Wheat Thresher



KT-350 Bean Thresher

TYT Grain Huller

The TYT series Grain Huller is mainly used for peeling grains, such as millet, sorghum, corn, wheat, barley, oats, soybeans etc. Especially, after taking off the hard shell of the skin and germ part of the corn, it improves the edible taste, and expands the application range of the corn.



TYT-200 Grain Huller

Model	Capacity (kg/hour)	Grinding wheel size (mm)	Power (kw)	Dimension (mm)	Weight (kg)
TYT-200	80	190×150×175	3	380×340×800	55
TYT-350	350	330×280×205	7.5	520×580×1000	135

Coffee Pulper

Coffee pulper is specialized designed for fresh coffee bean peeling. It can process 40-60kg/h coffee bean with proper thickness skin by hand.

Compact construct design, high working efficiency and favorable price make it become popular in all over the world.



Model	Dimension (mm)	Weight(kg)	Broken rate	Peeling rate	Loading
TP-120	540x310x570	16	0.5%-1%	99%-99.5%	One 20GP about 570pcs

5SSM-1 Dry Coffee Bean Huller

5SSM-1 Coffee Huller is used for hulling/shelling dry coffee beans. Coffee is fed through the hulling cylinder and forced through the perforated screen by the cross beaters. A powerful blower Separates the husk and peels from the coffee beans. An oscillating screen, adjusted by a step-less adjustable drive separates hulled and unhulled coffee. In the oscillating screen unhulled coffee moves towards the center of the screen and is collected through a duct. Whereas the hulled coffee beans move towards the outer rim of the screen and is discharged through an outlet duct.



Model	Capacity (ton/hour)	Power (kw)	Dimension Length*Width*Height (mm)	Weight (kg)
5SSM-1	2	15.75-22.75	1560*1540*3980mm	800

Seed Processing Line

SYNMEC seed processing machines can be connected together via elevator and used together as seed processing line.

Advantages:

- Easy to setup
- Labour saving
- Movable
- Variable machine combination
- Low cost



5XZC-5DH Seed Cleaner & Grader → 5XZ-5 Gravity Separator → 5XQS-5 Destoner



5XZC-5DH Seed Cleaner & Grader → 5XZ-5B Gravity Separator → 5BY-5B Seed Coating Machine → DCS-25S Bagging Scale System

5M Mobile Seed Processing Plant

Mobile Seed Processing Plant is designed for all grain, seed cleaning and processing.

- The plant consists of seed cleaner, gravity separator, destoner, indented cylinder, chemical seed treater, bagging scale and diesel generator.
- Various combination of equipment is available for multipurpose according to clients specific requirement.
- Available capacity (counted by wheat) : 1, 3, 5, and 10 tonshour
- Convenient operation with power control cabinet.
- Professional trailer system with excellent mobility apply to long distance transportation
- Silent diesel generator provides stable power suitable for remote place farm field working.

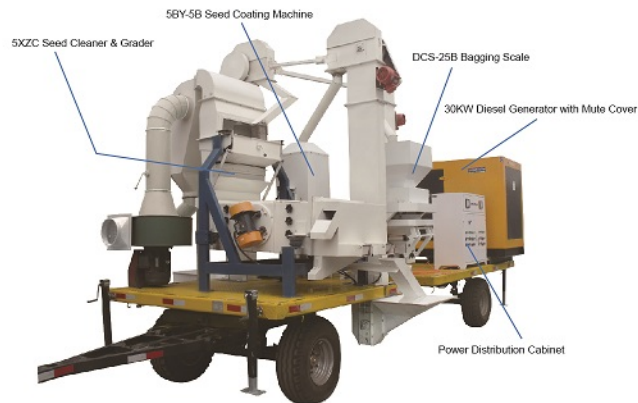

5M-5 Mobile Seed Processing Plant (5T/H capacity)

Grain & Bean Cleaning Plant

SYNMEC offers customized designed Grain/Bean Cleaning Plant and Seed Processing Plant for the high productivity requests in various grain processing. On-site installation and frontline training sessions are available. Our engineering team has a lot of experience and SYNMEC seed processing lines are now performing on almost four continents.



10T/H Pulses and Sesame Cleaning Plant in Ethiopia



10T/H Sorghum Cleaning Plant in Nigeria



10T/H Sorghum Cleaning Plant in Nigeria

The Grain & Bean Cleaning Plant normal includes:

1. Pre-cleaner for quickly removing large impurity
2. Seed Cleaner for removing small impurity, large impurity, light impurity, and dust.
3. Destoner for removing stones which in similar size with your grain or bean
4. Gravity separator for removing bad, broken and half seeds.
5. In bean cleaning plant, normal need Bean polishing machine for making the bean shine lead to increase the selling price in the market.
6. Finally quantitative packing via Bagging scale system.



2T/H Chia Seed Cleaning Plant in Uganda



8T/H Pulses and Sesame Cleaning Plant in Ethiopia

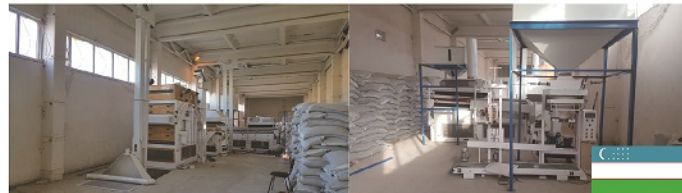

5T/H Green Mung Bean Cleaning Plant in Uzbekistan

Seed Processing Plant

We offer a range of seed processing plant for cleaning, chemical treatment and packaging the grain seed, which for multipurpose according to each client's specific requirements. Our engineer will make the special design.



5T/H Rice Seed Processing Plant in Ecuador



10T/H Barley Seed Processing Plant in Australia



1.5T/H Quinoa Seed Processing Plant in Australia

One seed processing plant mainly includes:

Pre-cleaner--seed cleaner--destoner--indented cylinder--gravity separator--seed coating machine--bagging scale system



10T/H Wheat and Barley Seed Processing Plant in Australia

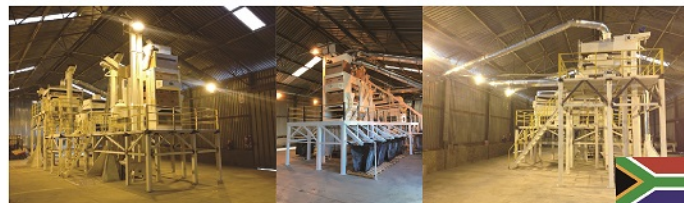

10T/H Sugar Bean Seed Processing Plant in South Africa



5T/H Maize Seed Processing Plant in South Africa